

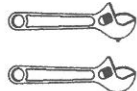

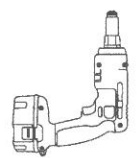



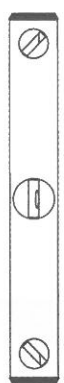

NÁVOD K INSTALACI

Kód produktu: ZS28503

DOPORUČENÉ NÁŘADÍ						
MONTÁŽNÍ MATERIÁL						
						

1

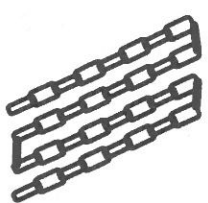
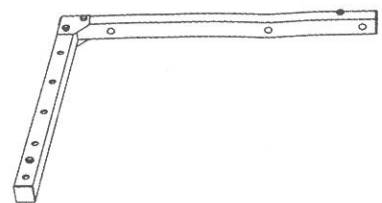
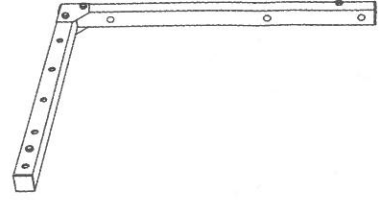
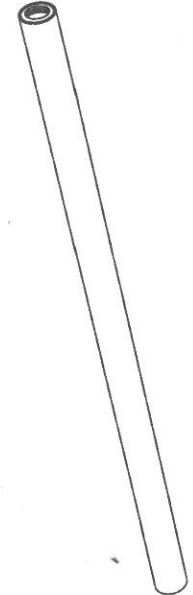
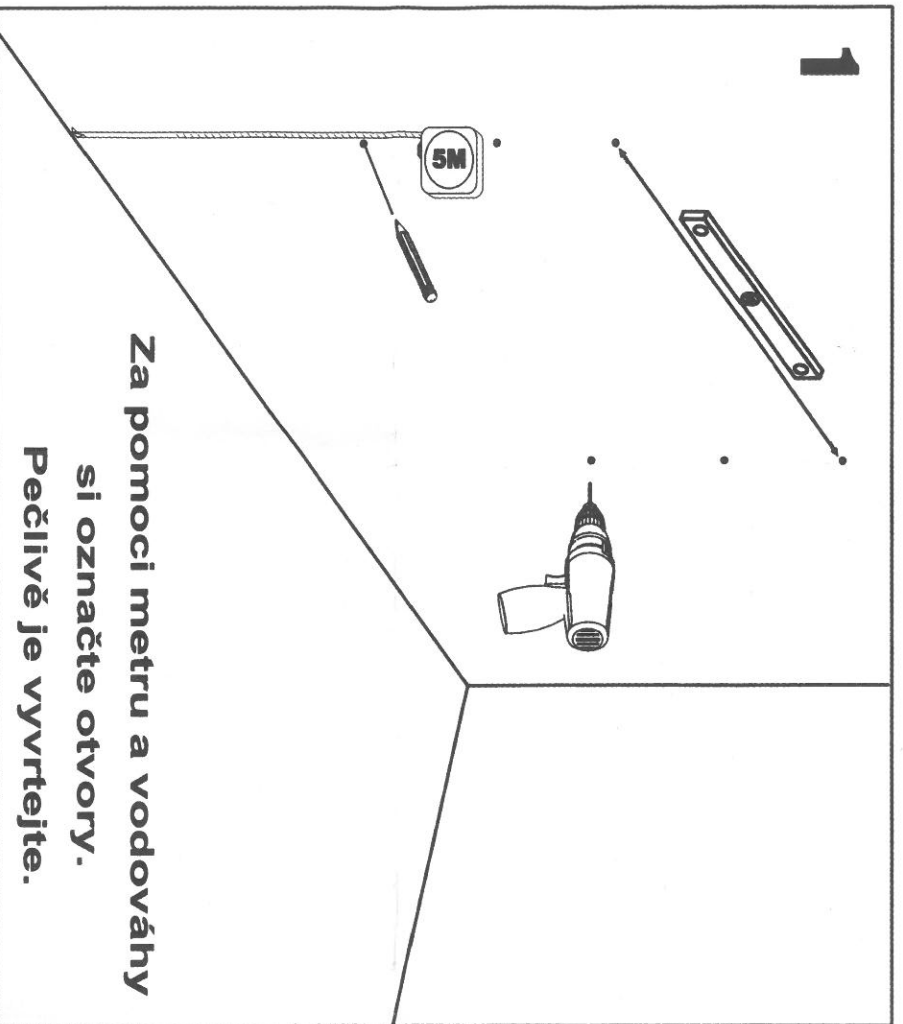

Za pomoci metru a vodováhy
si označte otvory.
Pečlivě je vyvrtejte.

2

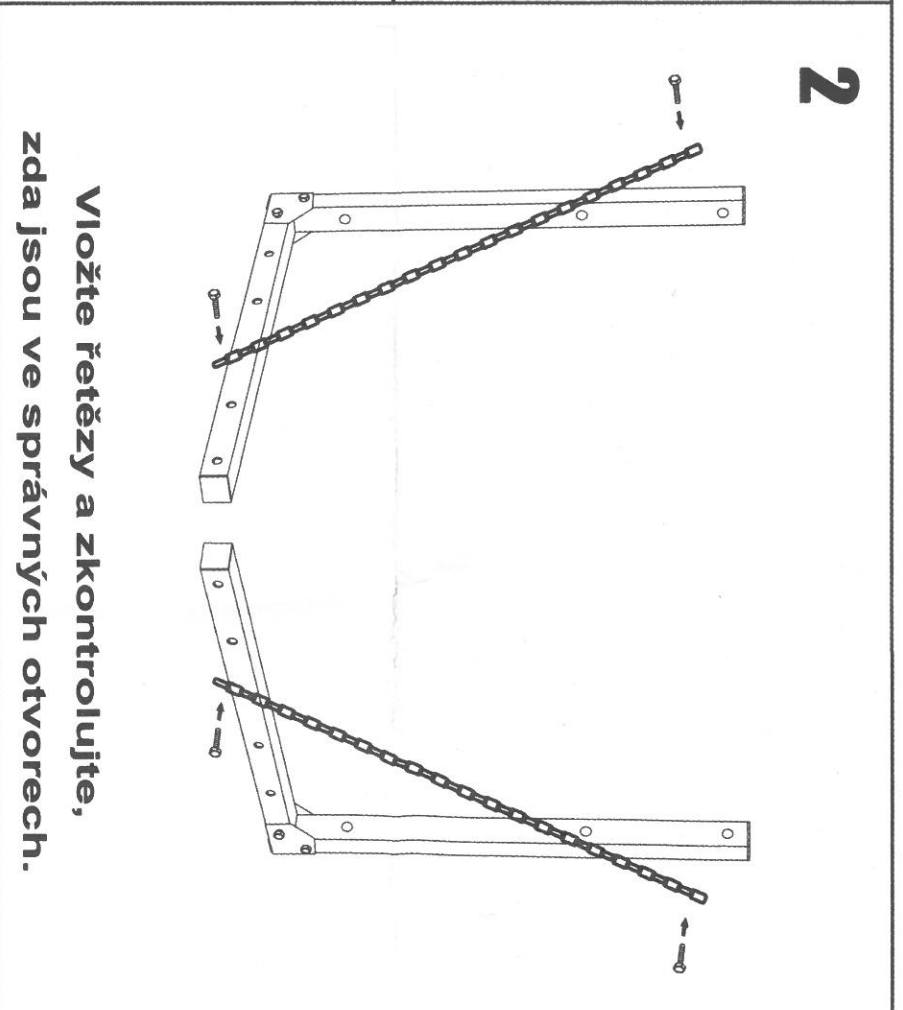

Vložte řetězy a zkontrolujte,
zda jsou ve správných otvorech.

3

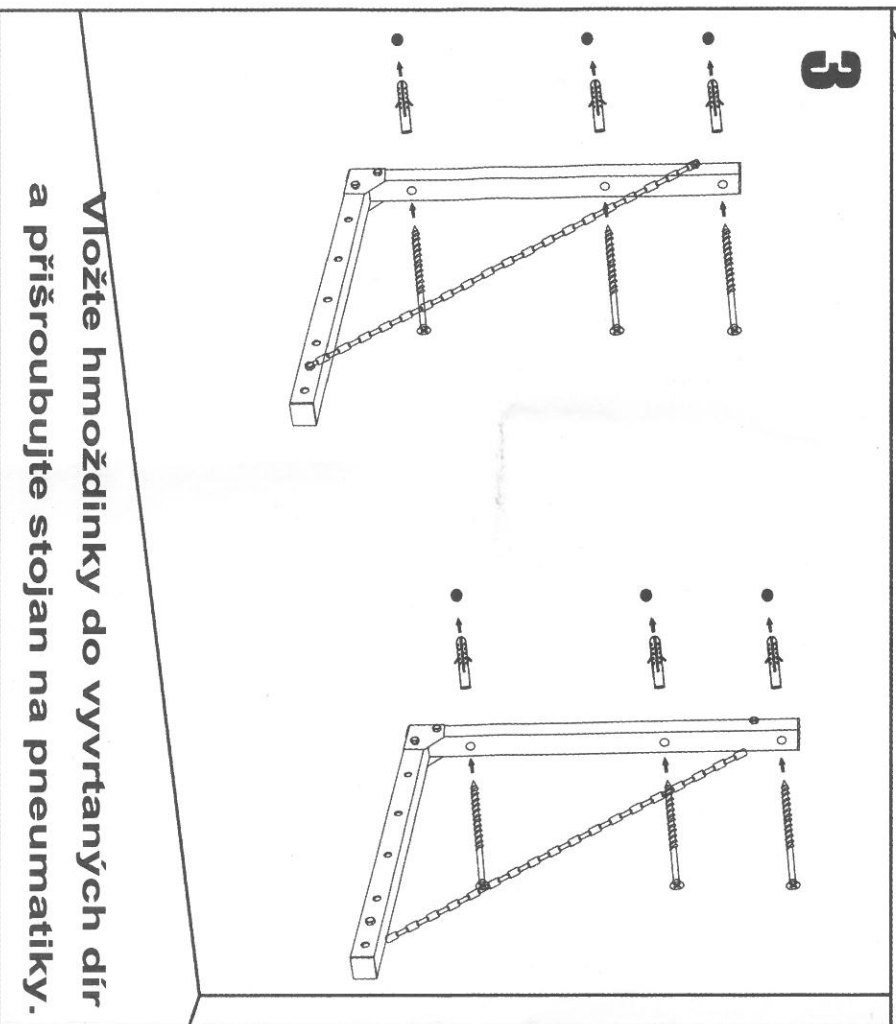

Vložte hmoždinky do vyvrtaných díř
a přišroubujte stojan na pneumatiky.

4

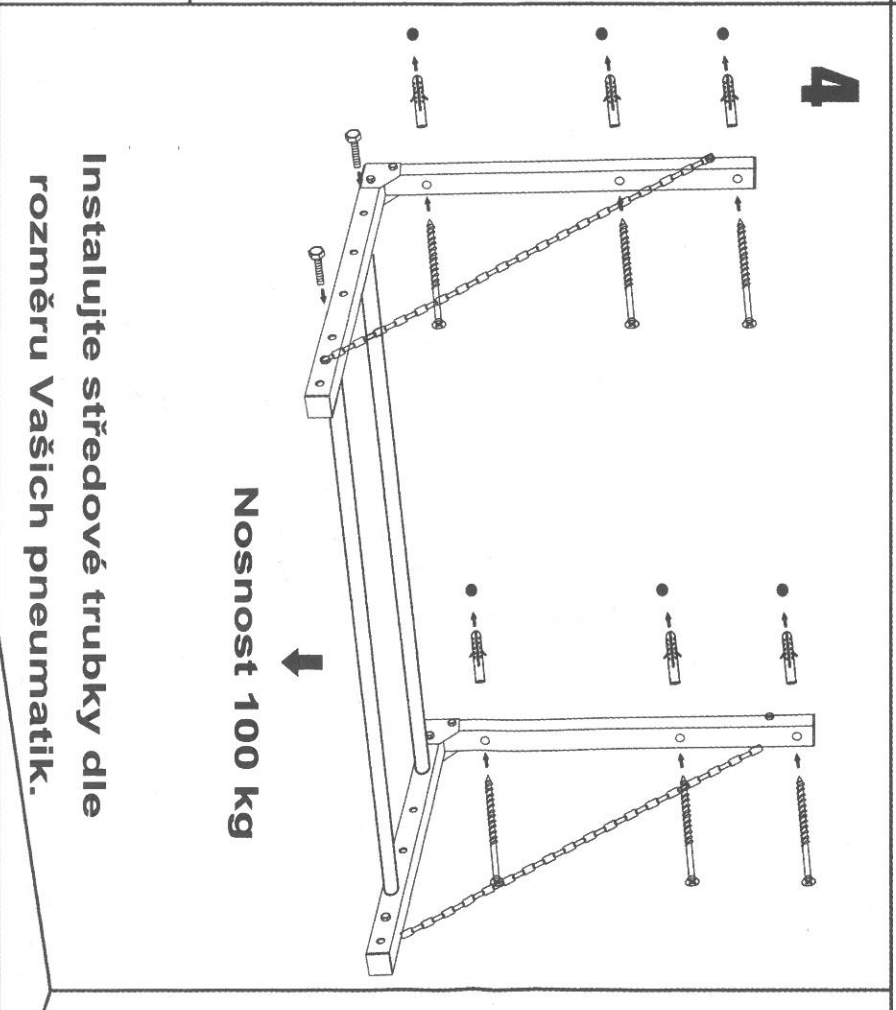

Instalujte středové trubky dle
rozměru Vašich pneumatik.
Nosnost 100 kg

Před instalací zkontrolujte, zda je zed' pro držák vhodná.
Dodržujte pracovní postup a dbejte na bezpečnost práce.
Nepřekračujte povolenou nosnost 100 kg.